

1 Ground Floor Plan
1 : 100

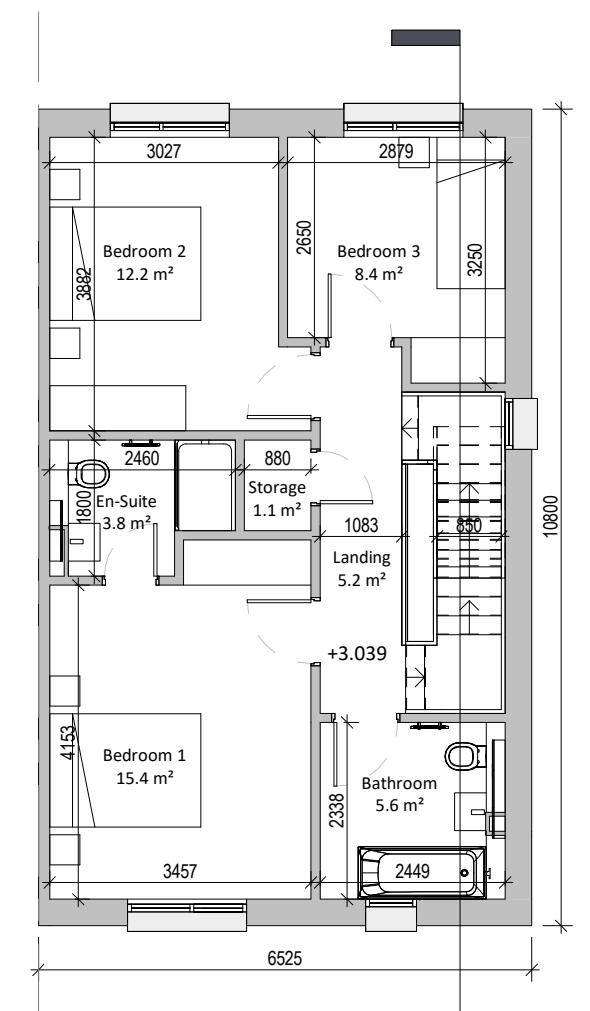

2 First Floor Plan
1 : 100

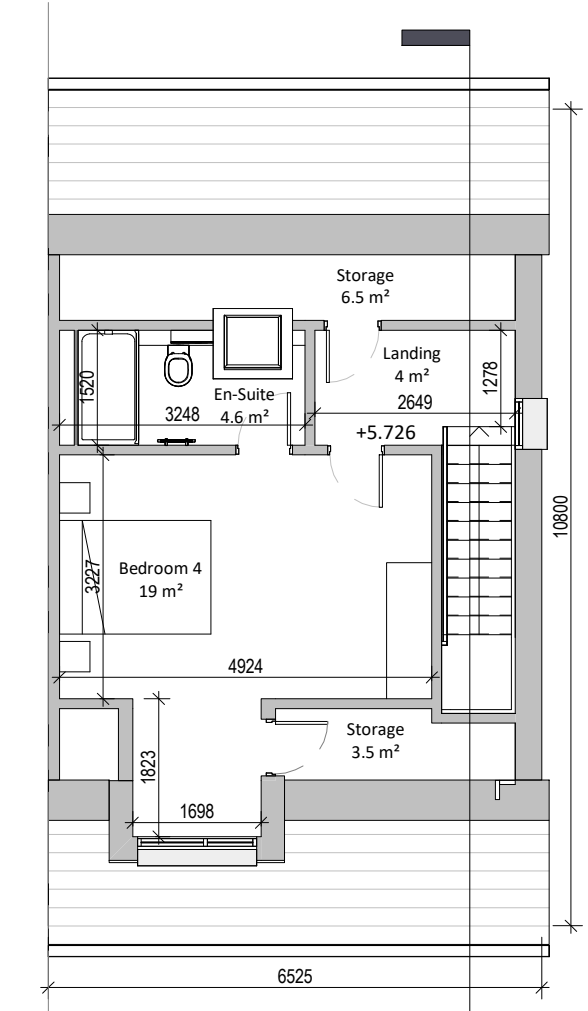

8 Second Floor Plan
1 : 100



3 Front Elevation
1 : 100

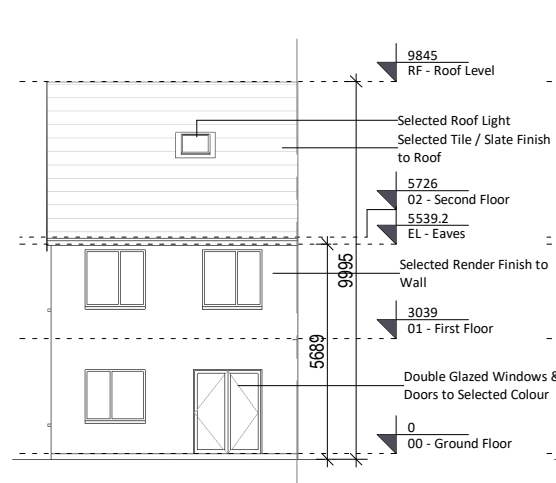

4 Rear Elevation
1 : 200

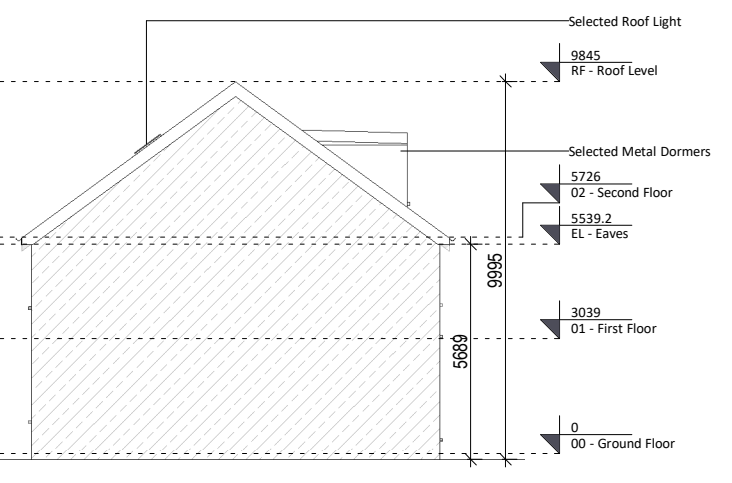

5 Left Elevation / Party Wall Section
1 : 200

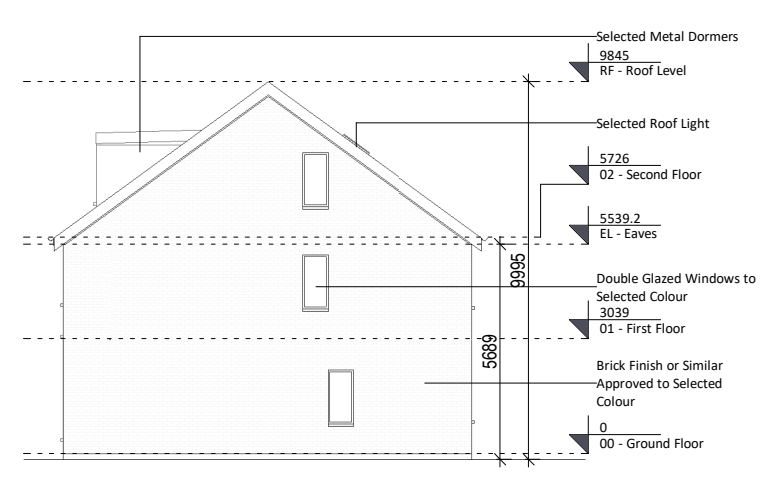

6 Right Elevation
1 : 200

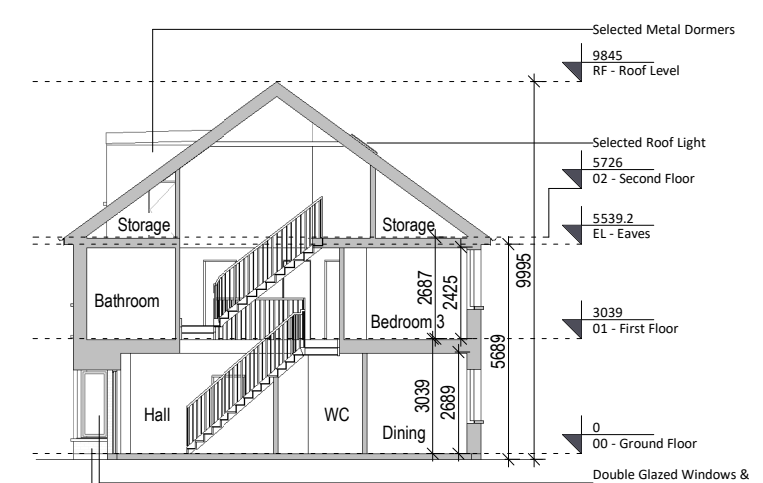

7 Section 1
1 : 200

House Type H4A1 (End of Terrace, Right) Plans Elevations and Section

| | |
|------------|-------|
| GIA | H4A1 |
| Level 00 | 57.9 |
| Level 01 | 60.7 |
| Level 02 | 43.3 |
| Total (m2) | 161.9 |

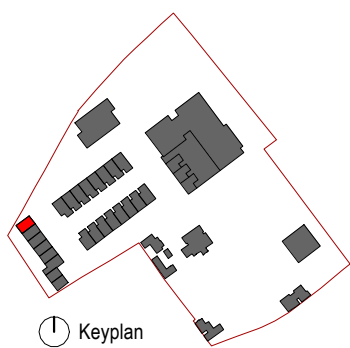

| Revision Description | Date | Rev. No. | Issued by |
|------------------------|------------|----------|-----------|
| LRD Stage 2 Submission | 07.06.2024 | C02 | SK |
| LRD Stage 3 Submission | 23.10.2024 | C03 | SK |

Any reference to fire safety design or performance is presented for coordination purposes only. Refer only to the granted Fire Safety Certificate, and fire consultant's information for fire safety design, specification and performance.

Figured dimensions only to be used. This drawing is copyright of O'Mahony Pike Architects Ltd. All information is shared as per approved use in accordance with ISO19650-2:2018, Table 5; Standard Codes for Suitability of Models and Documents and the BEP. If the 'Status' field is empty, this information has been shared at SO - WIP.

o'mahony pike

architecture | urban design | Dublin | Cork
 email: info@omahonypike.com | The Chapel | One South Mall
 tel: +353 1 202 7400 | Mount St. Anne's | Cork City
 fax: +353 1 283 0822 | Milltown, Dublin 6 | Co. Cork
 www.omahonypike.com | D06 XNS2 Ireland | T12 CCN3 Ireland

Project Code: 1307G
 Project Lead: SD
 Drawn By: SK
 Job No.: 1307G
 Purpose: LRD Stage 3 Submission

Scale @ A3: As indicated
 Date Printed: 23.10.2024
 Current Rev.: C03
 Status: A3

Project: Knockrabo Phase 2
 Location: Mt. Anville Road, Dublin 14
 Client: KIDAC

Drawing Title: House Type H4A1 (End of Terrace, Right) Plans Elevations and Section
 Drawing No.: 1307G-OMP-H4A1-ZZ-DR-A-1000

Source File: 1307G-OMP-HTC-ZZ-M3-A-0001.rvt